



THE i4



Highlights

- Exterior and interior design
- Driving dynamics
- Charging
- Connectivity and infotainment
- Assistance systems
- i meets M

Models

- Base
- M Sport package
- BMW i4 M50

Equipment

Exterior colour world

Interior colour world

Wheels and tyres

BMW Individual

Original BMW Accessories

Technical values

BMW Services

BMW i4 eDrive40:

19" aerodynamic wheels 855 bicolour with mixed tyres, exterior colour in Mineral White metallic, sport seats in 'Vernasca' leather Oyster decorative stitching | Black, interior trim finisher in fine-wood trim Oak grain open-pored with Pearl Chrome accent strip.

BMW i4 M50:

19" M light-alloy wheels double spoke 861 M bicolour with mixed tyres, exterior colour in BMW Individual Frozen Portimao Blue metallic, M sport seats in 'Vernasca' leather Black/contrast stitching Blue | Black, M interior trim finishers 'Carbon Fibre' with highlight trim finisher Pearl Chrome.

Alterations in standard and optional equipment and the configurations available for the different models, as described in this brochure, may occur after 03/21/2022, the date when this brochure went to press. Your local BMW Partner is available to provide further details. Subject to change in design and equipment.

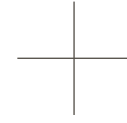

ELECTRIFYINGLY EMOTIONAL.

ATTRACTION IS SOMETHING THAT CANNOT
BE EXPLAINED. SOMETIMES, ALL IT TAKES IS
THE SLIGHTEST TOUCH. A SINGLE LOOK.
SOMETHING GRABS US, FLOWS THROUGH US,
WILL NOT LET US GO.
ATTRACTION BECOMES FASCINATION.
FASCINATION BECOMES ENTHUSIASM.
ENTHUSIASM BECOMES UTTER EUPHORIA.

ATTRACTION IS SOMETHING THAT CANNOT
BE EXPLAINED. BUT IT HAS TO BE EXPERIENCED:
IN THE BMW i4.



EMOTION – ELECTRICALLY INTERPRETED.

The BMW i4 wears its innovative character on its sleeve like the sporty extrovert it is. Its futuristic exterior design combines athletic aesthetics with a clear surface language

and progressive precision. The unique focal elements in the interior create a luxurious atmosphere that turns every drive into an unforgettable experience.

A LOOK TO SET YOUR PULSE RACING: THE FRONT END.

The front of the BMW i4 is characterised by expansive closed surfaces in the vehicle colour and precise lines. A black inlay in the front apron and vertical side openings emphasise the functional, modern character of the vehicle from this perspective. The absolute highlight, however, has to be the concise, almost closed reinterpretation of the radiator grille, with its exclusive, high-quality design: this is what it looks like to always be a step ahead of progress.



Designed to drive ahead:
the BMW i4 makes
e-mobility an emotional
experience.

■ A sign of intelligence and aerodynamics: The vehicle design with **radiator grille outlined in blue and the blue ring around the BMW badge** indicates the innovative technology of the BMW i4.

□ Flat, strikingly contoured **headlights** help the BMW i4 focus on what's going on in front. Blue accents in its richly detailed, slender form add an emotional flair – in this case, indicating the integrated **BMW Laserlight** system.

ROOM FOR EMOTIONS: THE INTERIOR.

Open, luxurious and fascinatingly aligned with the needs of the driver as well as those of all the passengers: the interior of the BMW i4 unveils the next generation of advanced driving. The interplay of high-quality materials,

a multimodal, intuitive operating concept and a sporty feel in the seat, with separated areas for the driver and front passenger, creates an atmosphere that is every bit as delightful on long journeys as it is during shorter drives.

■ The **BMW Curved Display**, with its curved connection between the 12.3" instrument cluster and 14.9" Central Information Display, adds a high-quality, modern touch to the cockpit of the vehicle. Curved towards the driver, it represents a particularly intuitive form of typical BMW driver orientation. Virtually all functions are integrated into the system – even the air conditioning controls can be accessed via the touchscreen. This means that physical switches only appear inside the BMW i4 where they make sense.



■ Standard equipment □ Optional equipment

The availability of some equipment features, functions and digital services depends on engine versions or additional optional equipment. The offer structure as well as market and production availability may vary. For detailed information about availabilities, duration and costs, contact your local BMW authorised workshop.

THE MATERIAL CYCLE OF A BATTERY CELL.

A battery cell goes through four stages of life in an electric vehicle: Development, use in the vehicle, second life, and battery recycling. We accompany

battery cells on their journey from their development in the BMW Group Competence Centre to their recycling.

Developing the battery cell technology of tomorrow: in the Battery Cell Competence Centre in Munich, the BMW Group searches for the ideal chemical composition for electrodes in a battery cell.

We can compare the development process of a lithium-ion battery cell with baking a cake. The cell chemistry is the recipe, while the four ingredients are the cathode, anode, separator, and electrolyte.

The battery cells are assembled into battery modules and the individual battery modules into batteries. The key phase in a battery's life now begins, namely its use in the vehicle.

Even when the battery in the vehicle has reached the end of its useful life after many years, it is not the end for the batteries by any means. In the Leipzig plant, for example, more than 2,600 BMW battery modules are used for the temporary storage of power. This second life use means that the battery cell can be used for another ten years on average as an energy store.

After the battery cells are shredded, their raw materials can be recycled. The BMW Group develops the recycling of secondary raw materials in the Battery Cell Competence Centre. The battery cell's lifecycle is then complete, ready to begin again.

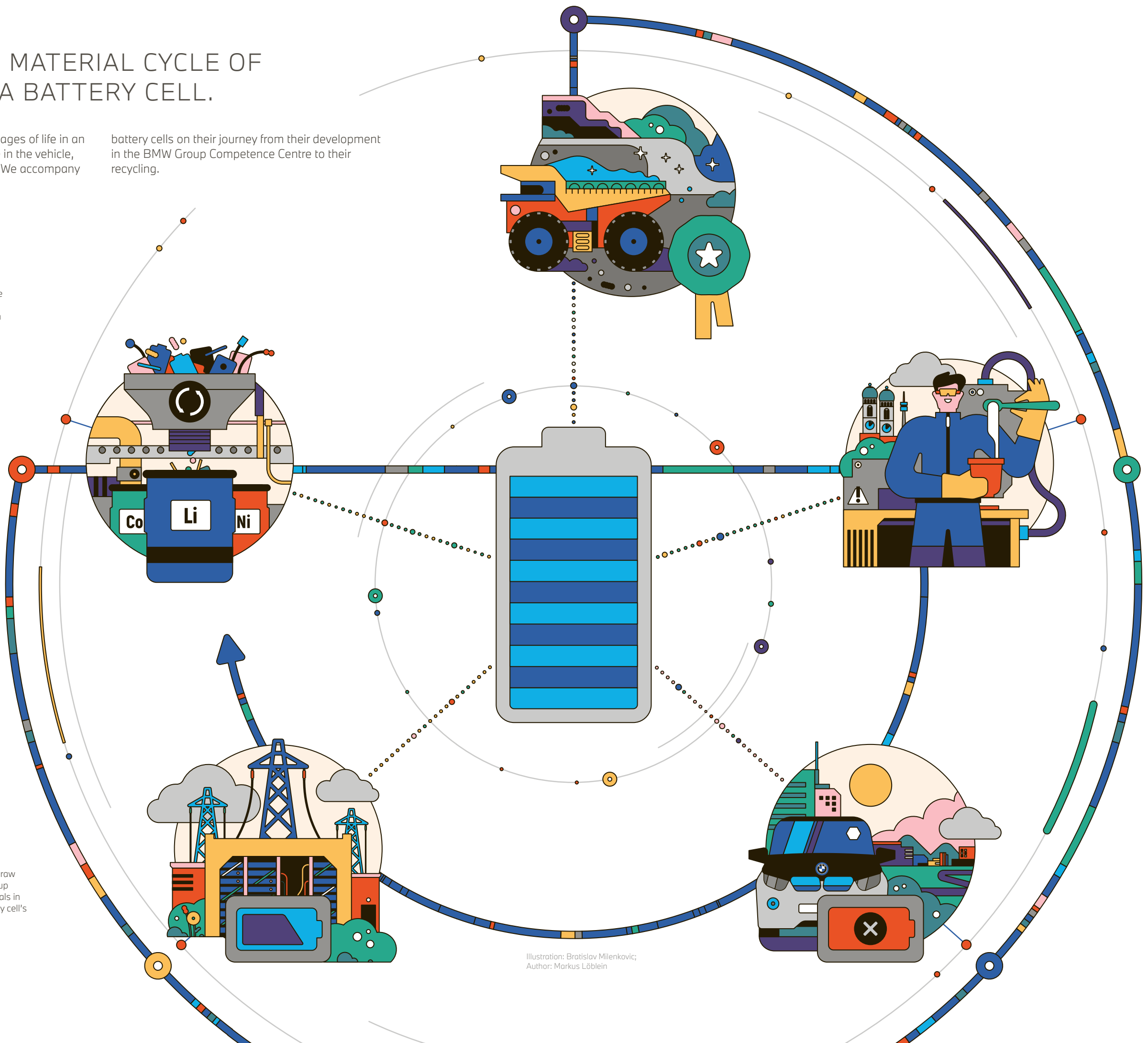

Illustration: Bratislav Milenkovic;
Author: Markus Löblein



SHEER DRIVING PLEASURE: UNLIMITED.

Thanks to its unique combination of powerful lithium-ion high-voltage battery and specific suspension kinematics, the BMW i4 will give you driving pleasure like never before. Excitingly dynamic, comfortable and powerful in equal measure, the BMW i4 exceeds all expectations – every day, every trip.

■ The combination of the rear wheel drive and the BMW eDrive engine give the BMW i4 **an outstanding sportiness**. Thanks to its rear axle air suspension, it also ensures **maximum comfort**, so that even longer trips become a pleasure.



■ The BMW i4 confidently sets standards, even off the racing track – and thanks to its particularly **short charging times**, a **roomy luggage compartment** and the comfortable space it offers for four passengers, it is the ideal partner for any daily routine.

■ Standard equipment □ Optional equipment

The availability of some equipment features, functions and digital services depends on engine versions or additional optional equipment. The offer structure as well as market and production availability may vary. For detailed information about availabilities, duration and costs, contact your local BMW authorised workshop.



Flexible charging
with up to
11 kW
power



ANYWHERE AT HOME – FLEXIBLE AND MOBILE CHARGING WITH THE FLEXIBLE FAST CHARGER.

■ The **flexible fast charger** included in the scope of delivery offers maximum flexibility for home charging. It always adapts to the charging infrastructure thanks to the available adapter cables and can be connected to both a domestic socket outlet and an industrial socket. You can take the compact, light flexible fast charger with you wherever you go and also charge your BMW in another "home", for example a second or holiday home.

RAPID CHARGING. DRIVE FURTHER. EXPERIENCE MORE.

BMW Charging is the all-round carefree solution for charging your BMW 2 Series Active Tourer plugin hybrid. With BMW Charging products and services, you have a wide range of tailor-made offers for charging available at home and on the road. This includes the charging cable for public

charging (mode 3), the Flexible Fast Charger and the BMW Charging Card as standard. You have worldwide access to a constantly growing network of charging points in city centres, car parks and along major traffic routes with BMW Charging at particularly good conditions.

EASY CHARGING NO MATTER WHERE YOU ARE, WITH THE BMW CHARGING CARD AND CHARGING CABLE FOR PUBLIC CHARGING.

■ Long journeys are a particular pleasure in the BMW i4 – after all, you already have everything you need to charge along the way:
with the **BMW Charging Card** you can seamlessly access an ample, cross-border charging network – including high-power charging stations for ultra-quick charging. For public charging in Europe, you benefit from particularly attractive and market-specific optimised rates, set up exclusively for BMW drivers and with no basic charge in the first year. With the **five-metre long standard charging cable (mode 3) for public charging** using alternating current (AC), all you need to do is connect your BMW i4 easily and safely to an AC charging post from the BMW Charging Network to charge the battery.



■ Standard equipment □ Optional equipment

The availability of some equipment features, functions and digital services depends on engine versions or additional optional equipment. The offer structure as well as market and production availability may vary. For detailed information about availabilities, duration and costs, contact your local BMW authorised workshop.

CONVENIENCE KNOWS NO BOUNDARIES.

Enhance your charging equipment with customised BMW Charging solutions. For instance with a Wallbox to charge your vehicle from home even more conveniently. Our installation service will be happy to connect it and set it up at your home for you. Or a green electricity tariff from renewable energies,

also for charging at home, with which your BMW i4 achieves maximum low-emissions charging and driving. The options are almost endless – with BMW Charging you can experience the fully fledged variety of modern mobility.

BMW WALLBOX FOR FAST AND CONVENIENT CHARGING AT HOME.

□ The BMW Wallbox¹ offers you safe, stress-free and fast charging. With the permanently installed robust BMW Wallbox for use outdoors, you can charge quickly and reliably with currently up to 22 kW².

Thanks to the integrated current leakage detection and a service app, installation is simple and cost-effective – and you can book this service for the BMW Wallbox right away.

ULTRA-FAST CHARGING HAS A NAME: IONITY.

On the road, you have access to BMW Charging's ever-growing public charging network, which includes a wide range of **high-power charging (HPC) stations e.g. from our partner IONITY** along the main traffic routes throughout Europe. These charging points can be displayed by the navigation system in the vehicle or by an app - all you need to do is set the appropriate filter. This enables ultra-fast charging with direct current (DC) at an HPC charging point: The battery of a BMW i4, for example, is charged from 10 to 80 percent in 31 minutes with up to 205 kW charging power.

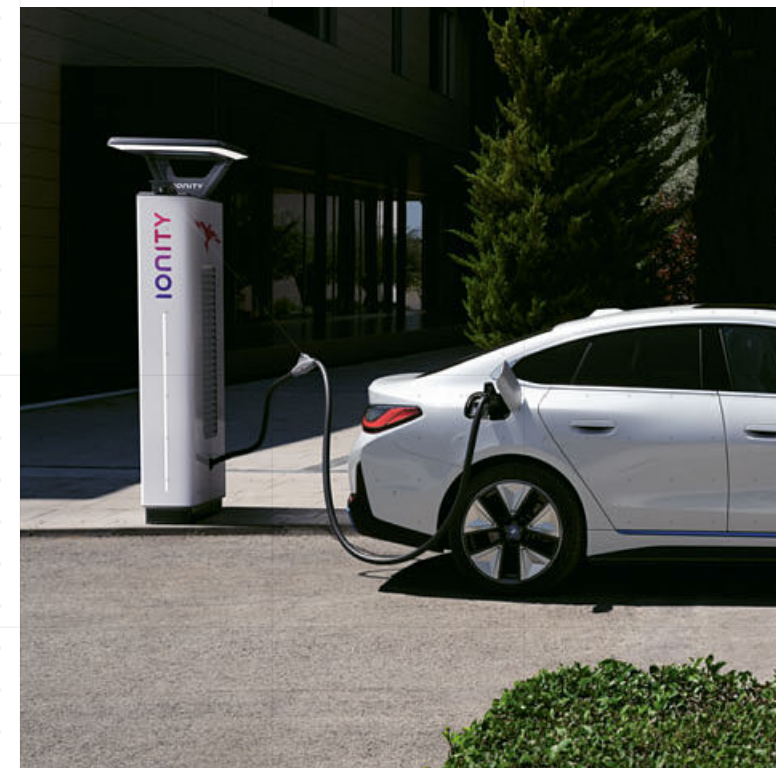

SMART WALLBOX:

□ Even smarter charging at home: In addition to a charging power up to 22 kW² the Smart Wallbox offers our partners comprehensive connectivity. This makes smart, additional services for intelligent charging possible. For instance, the Smart Wallbox¹ can be integrated into an existing home energy management system and conveniently controlled online. Accurate registering and billing of charging processes is also possible.



The availability of some equipment features, functions and digital services depends on engine versions or additional optional equipment. The offer structure as well as market and production availability may vary. For detailed information about availabilities, duration and costs, contact your local BMW authorised workshop.

■ Standard equipment □ Optional equipment

¹ Equipment available as an option from Original BMW i Accessories.

² Up to 11 kW in the BMW i4.



THE FLOW OF A NEW TIME.

► A day in an electric BMW of the current generation promises pure excitement – no matter how you organise your day.

8:40 a.m.

Inside the house, a hot espresso wakes the spirits, outside on the all-electric BMW, the BMW Wallbox does the job – the high-voltage battery is charged faster than a normal domestic socket outlet ever could. The My BMW App lets you keep an eye on the current charging status at all times. You and your electric BMW: Ready to go!

You've set the departure time to 9.00 a.m. via the My BMW app – this means that the high-voltage battery and the interior are already optimally preconditioned when the journey begins. You also set your profile picture via the MY BMW App. Open your BMW conveniently with the Digital Key by simply holding your iPhone up to the vehicle door so that you can get in and start immediately – it doesn't get much smarter than that. Quickly select your desired playlist by voice using BMW Intelligent Personal Assistant and start your journey with your favourite music.

10:15 a.m.

BMW Maps shows another 85 km to your destination. The blue circle on the navigation map shows at a glance that the range is not sufficient to reach that point. Conveniently, Connected Charging immediately shows you possible charging stations on the way in the Control Display.

2:30 p.m.

The meeting was a complete success! Because the afternoon is free and you have your sports gear and running shoes with you, all it takes is a quick call to a friend whose home is on the way back and a jogging appointment has been made. Before you set off, you quickly connect your BMW and the high voltage socket at home using the Flexible Fast Charger – this way, the charger gets the maximum number of kilometres out of your spontaneous running meeting.

6:00 p.m.

Almost silently, the BMW rolls under the carport. The high-voltage battery still has enough power for many more kilometres – but tomorrow there's another long trip on the agenda. No problem: simply connect your vehicle to the BMW Wallbox. In addition to access to a host of charging functions and your charging history, you can also automatically supply your vehicle with energy in the most favourable period depending on the energy tariff and departure time. One thing is certain: an electric BMW will always remain a BMW, and another day full of high-octane driving pleasure awaits.

PROGRESS THAT CONNECTS.

Leave everything behind – but stay connected to what is important to you: The extensive connectivity and infotainment functions in the BMW i4 ensure that you are at the centre of the action on every trip – no matter where the road takes you.



□ Use real-time navigation, make calls, dictate and listen to text messages, listen to music and more: Thanks to smartphone integration¹, numerous functions of your iPhone are easily and safely available in the vehicle with **Apple CarPlay**[®]. Apps can be conveniently controlled directly via Siri with your voice without manual input. When navigating with Apple Maps, the map is displayed on a large scale in the instrument cluster of the BMW i4. Instruction given by the navigation system are also shown in the Head-up Display².



■ With **BMW iDrive**, you can enjoy an even more convenient and innovative range of options for controlling your BMW i4. In conjunction with the large **BMW Curved Display** it ensures that you can see all information clearly without having to search for it. This is also supported by the **BMW Operating System 8**, which can be used intuitively via touchscreen, iDrive Controller and voice control thanks to its progressive, modern user interface.

■ Actively supporting you every day: The Automate my habits function offered by the **BMW Intelligent Personal Assistant** allows you to automate functions you use repeatedly as soon as a specific trigger occurs. The intuitive and emotional visualisation of the BMW Intelligent Personal Assistant will ensure you always have a clear overview.

■ Standard equipment □ Optional equipment

The availability of some equipment features, functions and digital services depends on engine versions or additional optional equipment. The offer structure as well as market and production availability may vary. For detailed information about availabilities, duration and costs, contact your local BMW authorised workshop.
¹ Smartphone Integration is permanently available in the vehicle. It includes Apple CarPlay and Android Auto. Due to possible future technical developments

(e.g. of mobile phones), the usability of the Apple CarPlay or Google Android Auto service cannot be guaranteed permanently. CarPlay is a trademark of Apple Inc. Android Auto is a trademark of Google LLC.
² The information in the BMW Head-Up Display is not fully visible when viewed through polarised sunglasses. Content shown will depend on the equipment options chosen. Further optional equipment is required to display specific items.

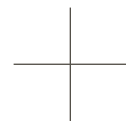

TECHNOLOGY OPTIMISED TO SUIT YOUR NEEDS.

The BMW i4 is always at your side, providing reliable support even in challenging driving situations. A smart combination of sensors, assistance systems and safety technologies ensures that you feel perfectly at ease on every journey and can skilfully master any situation.

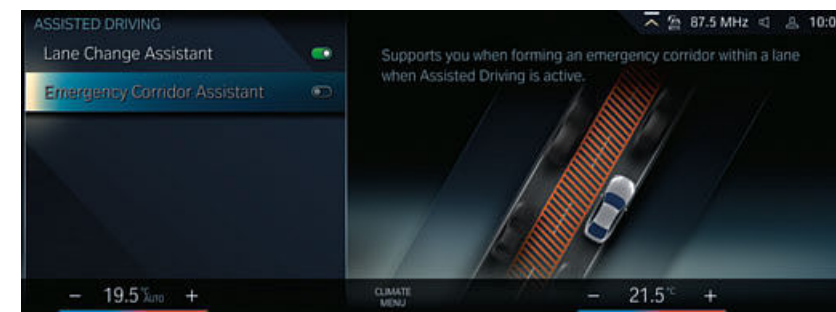

▣ **Driving Assistant Professional¹** supports you like a smart co-pilot. It prepares your vehicle perfectly for each lane change, takes over the steering in slow-moving traffic, automatically creates an emergency lane when necessary, and much more. This means that you can concentrate fully on the thing that is the most pleasing about the BMW i4: that unique electric driving feel.

▣ Making bothersome routines a pleasure: its numerous cameras will improve your overview and make it easier to manoeuvre and park your BMW i4. If you like, the **Parking Assistant Plus²** can even park your car for you and drive it back out of your parking space – everything about the BMW i4 is geared towards making every drive a unique experience from start to finish.



■ Standard equipment ▣ Optional equipment

¹ Function may be limited in darkness, fog or bright glare.
² The driver is responsible for constantly monitoring the automated parking procedure in accordance with local road laws.

The availability of some equipment features, functions and digital services depends on engine versions or additional optional equipment. The offer structure as well as market and production availability may vary. For detailed information about availabilities, duration and costs, contact your local BMW authorised workshop.

PURE ADRENALINE MEETS ELECTRIFYING FORWARD THRUST.

A new era: in launching the BMW i4 M50, BMW M is transferring the athletic design, powerful drivetrain systems and precise vehicle handling of BMW M to an innovative BMW i for the very first time.



LIVE AND AT THE TOP.

The M logo in the radiator grille and the blue BMW i ring mark the best of both worlds. The closed radiator grille with its premium patterning, an M rear spoiler and expressive aerodynamically optimised diffuser elements, in addition to numerous M-specific design details are the visual signs of a highly dynamic driving experience that has never before been seen.

■ The pure performance of the BMW i4 M50 is strikingly reflected in its powerful, athletic exterior design. Numerous M-specific elements, such as the **M aerodynamic package**, **M light-alloy wheels**, an **M logo on the radiator grille and on the front side panels on the right and left**, **M exterior mirror** and design elements in the **M signature colour Cerium Grey**, impressively showcase the symbiosis of strong power pack and agile athlete.

■ The sporty, exclusive interior of the BMW i4 M50 intensifies that feeling of ultimate driving pleasure: sitting in its **sport seats with their distinctive M upholstery** makes it feel even more exciting to be driving out in front of all the rest. The expressive **M leather steering wheel** with its worked-in seams in the characteristic M colours gives you total control. This consistent quest for dynamism is reflected even in the smallest details – for example, when the **exclusive M interior trim finishers** excite you about getting on the road as soon as you enter the car.

■ Standard equipment □ Optional equipment

The availability of some equipment features, functions and digital services depends on engine versions or additional optional equipment. The offer structure as well as market and production availability may vary. For detailed information about availabilities, duration and costs, contact your local BMW authorised workshop.

COMPLETELY DYNAMIC.
ELECTRICALLY INTERPRETED.

What do you feel when you drive the BMW i4 M50? Pure ecstasy – the unique, characteristic M driving experience. Also as an electric model, a BMW M vehicle unites dynamic top performance and adrenaline-charged electric handling with complete suitability for everyday driving.



■ In **Sport Boost mode**, the two BMW M eDrive engines unleash **up to 400 kW (544 hp)** and seamlessly accelerate the BMW i4 M50 **from 0 to 100 km/h in just 3.9 seconds** – values that impressively showcase the uncompromisingly athletic character of the BMW i4 M50.

■ Every M model is distinguished by the driving experience that is typical of the brand. The BMW i4 M50 also excels in this respect. With **adaptive M suspension, variable sport steering, the M sport brake and M-specific settings**, it drives precisely and dynamically – and thanks to its extra low centre of gravity, it enjoys a particularly sporty position on the road.

■ Standard equipment □ Optional equipment

The availability of some equipment features, functions and digital services depends on engine versions or additional optional equipment. The offer structure as well as market and production availability may vary. For detailed information about availabilities, duration and costs, contact your local BMW authorised workshop.

MODEL VARIANTS AT A GLANCE.

BASE

Pure emotions that electrify: Dynamic and expressive, the BMW i4 shows what it means to combine its sporty character and a next-generation electric drive. At the same time, it captivates with its clear surface language and precise, modern appearance, even at first glance.



M SPORT PACKAGE



Drift of emotions: The M Sport package emphasises once more the especially athletic alignment of the BMW i4 with its dynamically designed exterior and exclusive equipment range in the interior.

BMW M AUTOMOBILES

i4 M50



One vehicle, the best of both worlds: For the first time in its history, a vehicle combines the elements of BMW i and BMW M. It is thus ahead of the game while visually expressing the innovative drive technology of the future.

BASE.



■ The black Sport leather steering wheel with four spokes features a Pearl Chrome decorative trim. A thick rim and contoured thumb rests provide an exceptionally pleasant, high-grip feel.



■ The Sport seats for driver and front passenger provide optimum lateral support with their raised side bolsters and manually adjustable thigh support. In addition, the seat's fore-and-aft position and height can be adjusted manually.



■ 17" light alloy wheels V-spoke style 851 Silver Grey uni, wheel size 7.5J x 17 with 225/55 R17 tyres.



□ 19" aerodynamic wheels 855 Bicolour Dark Grey with mixed tyres, gloss-lathed, wheel size front 8.5J x 19 with 245/40 R19 tyres, wheel size rear 9J x 19 with 255/40 R19 tyres.

SELECTED BASE MODEL EXTERIOR EQUIPMENT FEATURES:

- LED headlights
- Rear lights with LED technology
- Recuperation system
- 17" light alloy wheels V-spoke style 851

SELECTED BASE MODEL INTERIOR EQUIPMENT FEATURES:

- BMW Live Cockpit Plus
- Sport leather steering wheel
- Automatic air conditioning
- Stereo speaker system
- Steptronic transmission
- Sport seats for driver and front passenger
- Cloth/Sensatec combination | Black
- High-gloss Black interior trim
- Floor mats in velour
- Instrument panel in Sensatec

The availability of some equipment features, functions and digital services depends on engine versions or additional optional equipment. The offer structure as well as market and production availability may vary. For detailed information about availabilities, duration and costs, contact your local BMW authorised workshop.

■ Standard equipment □ Optional equipment

M SPORT PACKAGE.



■ The M Aerodynamics package with M-specific front and rear apron in the vehicle colour, design elements on the side sills in Black high-gloss and a two-piece diffuser insert in Dark Shadow metallic and Black high-gloss conveys pure dynamics and sporting character.



■ M leather steering wheel including multifunction buttons, steering wheel rim in leather 'Walknappa' Black with contoured thumb rests.



■ Interior trim Aluminium Rhombicle Anthracite with highlight trim finisher in Pearl Chrome



■ 18" M aerodynamic wheels 858 M Bicolour Black Grey with mixed tyres, gloss-lathed, wheel size front 8.5J x 18 with 245/45 R18 tyres, wheel size rear 9J x 18 with 255/45 R18 tyres.



□ 19" M light alloy wheels Y-spoke style 859 M Bicolour Jet Black uni with mixed tyres, gloss-lathed, wheel size front 8.5J x 19 with 245/40 R19 tyres, wheel size rear 9J x 19 with 255/40 R19 tyres.

M SPORT PACKAGE EXTERIOR EQUIPMENT:

- M Aerodynamics package with front apron, side sills and rear apron in vehicle colour with multi-piece insert in rear bumper in Dark Shadow metallic and Black high-gloss
- 18" M aerodynamic wheels 858 M Bicolour with mixed tyres; other wheels available
- M high-gloss Shadow Line, alternatively BMW Individual Exterior Line Aluminium satinised
- M designation on the sides
- Roof trim strip in vehicle colour
- Exclusive M Portimao Blue metallic paintwork or M Brooklyn Grey metallic; other paintwork available

M SPORT PACKAGE INTERIOR EQUIPMENT:

- M entry sills
- M driver footrest and M pedals
- Sport seats for the driver and front passenger in Alcantara/Sensatec combination with perforation and Blue contrast stitching; other upholsteries available
- Seat backrest width adjustment
- M leather steering wheel
- Vehicle key with exclusive M logo
- M anthracite headliner
- M interior trim finishers in Aluminium Tetragon; other trims available

■ Standard equipment □ Optional equipment

The availability of some equipment features, functions and digital services depends on engine versions or additional optional equipment. The offer structure as well as market and production availability may vary. For detailed information about availabilities, duration and costs, contact your local BMW authorised workshop.

BMW i4 M50



■ The M High-gloss Shadowline includes numerous equipment features in Black high-gloss. These include the window recess cover, the window surrounds, the exterior mirror frame, the mirror triangle and blade.



■ In the SPORT BOOST driving mode, the BMW M eDrive engines provide added performance of up to 50 kW (68 hp). In this case the drive reacts more sensitively to the acceleration commands. The clearly noticeable boost function provides superior engine power and thus creates a unique, particularly sporty driving experience.

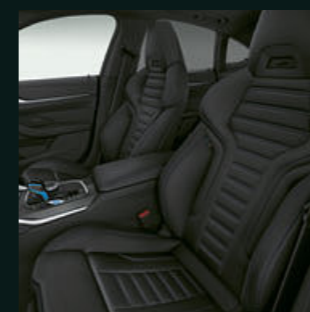

□ The multi-adjustable M Sport seats with bucket seat character and partly integrated headrest provide excellent lateral support for you and your front passenger.

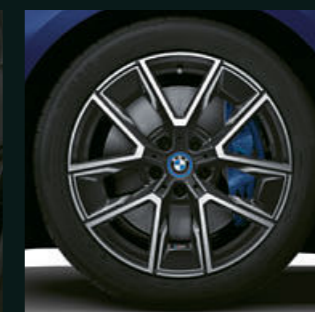

■ 18" M aerodynamic wheels 858 M Bicolour Black Grey with mixed tyres, gloss-lathed, wheel size front 8.5J x 18 with 245/45 R18 tyres, wheel size rear 9J x 18 with 255/45 R18 tyres.

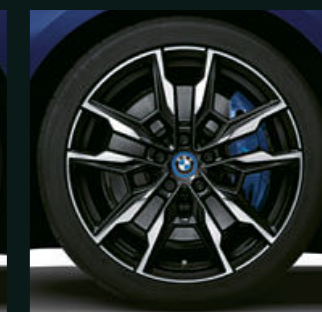

□ 19" M light alloy wheels Double-spoke style 861 M Bicolour Jet Black uni with mixed tyres, gloss-lathed, wheel size front 8.5J x 19 with 245/40 R19 tyres, wheel size rear 9J x 19 with 255/40 R19 tyres.

THE EQUIPMENT RANGE OF THE i4 M50 IN THE EXTERIOR:

- M rear spoiler
- M high-gloss Shadow Line
- 18" M aerodynamic wheels 858 M bicolour with mixed tyres
- SPORT BOOST
- Adaptive M suspension
- Variable sport steering
- M Sport brakes

THE EQUIPMENT RANGE OF THE i4 M50 IN THE INTERIOR:

- Alcantara/Sensatec combination | Black/contrast stitching in blue
- M Aluminium Rhombicle Anthracite interior trim strips
- M Anthracite headliner
- BMW IconicSounds Electric
- M steering wheel

■ Standard equipment □ Optional equipment

The availability of some equipment features, functions and digital services depends on engine versions or additional optional equipment. The offer structure as well as market and production availability may vary. For detailed information about availabilities, duration and costs, contact your local BMW authorised workshop.

EQUIPMENT HIGHLIGHTS.



□ The M Leather steering wheel including multifunction buttons, an M badge and an integrated driver-side airbag is featured in three-spoke design. With a reinforced steering wheel rim in leather 'Walknappa' Black with black stitching and contoured thumb rests, it provides a direct, athletic steering sensation.



□ The top of the BMW Individual instrument panel is covered in black 'Walknappa' leather and the underside in black 'Merino' leather. In addition, it includes black-grey contrasting stitching at the top. The sophisticated aesthetic of this high-quality trim gives the interior an even more luxurious feel.



□ Exclusive galvanic embellishers for controls such as the window lifts, the control centre for the door, the door lock switch, as well as, depending on the equipment, the multifunction buttons on the steering wheel lend a particularly high-quality look.

■ The black Sport leather steering wheel with four spokes features a Pearl Chrome decorative trim. A thick rim and contoured thumb rests provide an exceptionally pleasant, high-grip feel.



□ At the touch of a button, the steering wheel heating quickly warms up the steering wheel rim to a pleasant temperature. The steering wheel gives you a pleasant warm feeling even when it's cold outside, allowing you to comfortably and safely steer the vehicle without the encumbrance of gloves – a great boost in comfort, especially during the winter months. The activation button is easily accessible directly on the steering wheel.

■ Standard equipment □ Optional equipment

The availability of some equipment features, functions and digital services depends on engine versions or additional optional equipment. The offer structure as well as market and production availability may vary. For detailed information about availabilities, duration and costs, contact your local BMW authorised workshop.

EQUIPMENT HIGHLIGHTS.



□ The tonally outstanding Harman Kardon surround sound system features a 535 W digital amplifier, nine channels and 17 speakers. Its sophisticated sound perfectly fills the interior space. Vehicle-specific, speed-dependent equalising precisely compensates for any background driving noise.



□ Through the BMW Live Cockpit Professional emerges a frameless BMW Curved Display that combines a 12.3" instrument display and a 14.9" touch display. In addition, relevant information is projected onto the windscreen via the BMW Head-Up Display¹.

■ The BMW Live Cockpit Plus comprises a curved display combination with a 12.3" instrument display and a 14.9" control display with touch function. Two USB ports, a Bluetooth^{®2}/Wi-Fi interface are also included in the equipment package.

■ The one-piece Widescreen Display pairs ergonomically optimised intuitive operation with a display combination consisting of a 12.3" instrument display and a 14.9" control display. The latter can be conveniently controlled via a touchscreen. The free-floating look and the curved shape of the Widescreen Display provide an elegant impression.



■ Standard equipment □ Optional equipment

The availability of some equipment features, functions and digital services depends on engine versions or additional optional equipment. The offer structure as well as market and production availability may vary. For detailed information about availabilities, duration and costs, contact your local BMW authorised workshop.

¹ The information in the BMW Head-Up Display is not fully visible when viewed through polarised sunglasses. Content shown will depend on the equipment options chosen. Further optional equipment is required to display specific items.

² The Bluetooth[®] wordmark and logos are registered trademarks owned by Bluetooth SIG, Inc. Any use by the BMW Group takes place within the framework of an End User License Agreement.

EQUIPMENT HIGHLIGHTS.

□ BMW Maps with Connected Navigation and Connected Parking, Connected Music, Smartphone Integration¹ incl. Apple CarPlay and Android Auto and In-Car Experiences – the Connected Package Professional provides extensive networking capability for your BMW. You benefit from increased comfort and seamless integration of your smartphone apps.

□ Whether it's phone calls or data usage – with the Personal eSIM you can also use your own mobile communications contract for your BMW. Your smartphone does not have to be in the vehicle. You benefit from better reception because you automatically use the vehicle's external antennas. More connectivity: Your BMW is 5G-enabled and offers a Wi-Fi hotspot.



□ Why go without the features of your smartphone in your BMW when you can continue operating it as usual? With smartphone integration¹, your vehicle supports Apple CarPlay and Android Auto by means of a wireless connection between your smartphone and the vehicle. This allows you to conveniently use familiar functions and various apps in the vehicle.



□ With Remote 3D View, you can see your parked vehicle's surroundings from a distance on a smartphone. The function can be activated via the My BMW App. The 3D images can also be stored on the smartphone.

□ BMW Maps – Connected Navigation impresses with high accuracy of the predicted arrival time, extremely fast route calculation and simplified destination entry. This is possible through free text input. The cloud-based dynamic route calculation immediately adapts the route recommendation to any changes in the traffic situation.

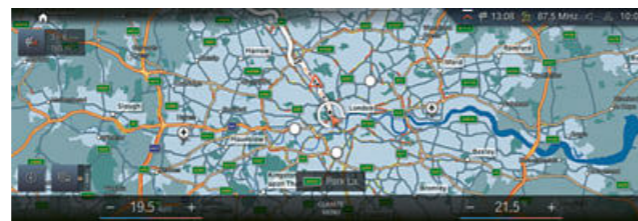

□ Listen to your favourite music wherever you are. Classical on the motorway, jazz during rush hour and pop when you're cruising. Connected Music with Spotify means you can directly stream countless millions of songs without any limits via BMW's music partner Spotify, using the SIM card installed in your vehicle.

■ Standard equipment □ Optional equipment

¹ Smartphone Integration is permanently available in the vehicle. It includes Apple CarPlay and Android Auto. Due to possible future technical developments (e.g. of mobile phones), the usability of the Apple CarPlay or Google Android Auto service cannot be guaranteed permanently. CarPlay is a trademark of Apple Inc. Android Auto is a trademark of Google LLC.

The availability of some equipment features, functions and digital services depends on engine versions or additional optional equipment. The offer structure as well as market and production availability may vary. For detailed information about availabilities, duration and costs, contact your local BMW authorised workshop.

EQUIPMENT HIGHLIGHTS.

□ The Adaptive M suspension¹ can be electrically adjusted at any time to suit the road and driving conditions. You can also adjust the suspension characteristics via the Driving Experience Control to enable your preferred driving style at the time – from comfortable to extremely athletic with markedly agile handling.

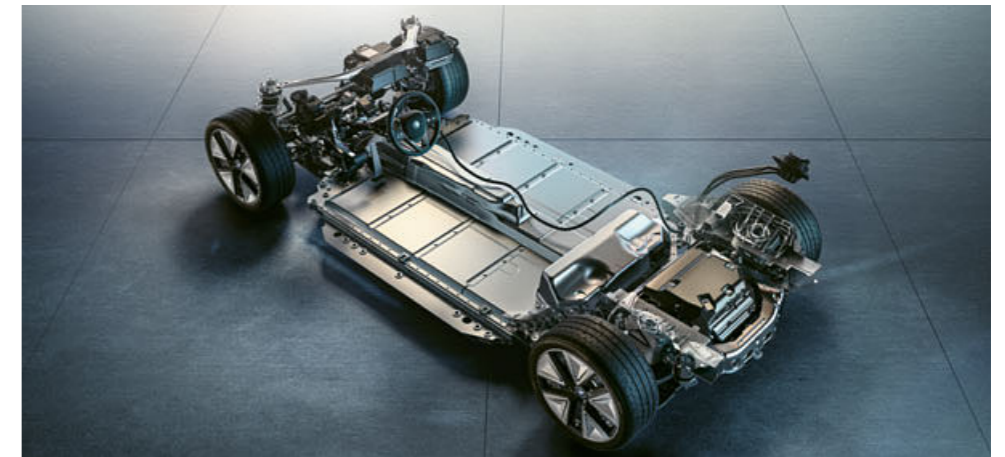

□ The variable sport steering¹ including Servotronic continuously adjusts the steering effort required and steering force depending on the current speed and on the angle of the steering wheel.

□ Driving Assistant Professional² offers optimum comfort and safety during monotonous or complex driving situations. Apart from the contents of the Driving Assistant, it includes numerous other functions to make your journeys even safer and more enjoyable. The Distance Control (ACC with Stop&Go) including front collision warning with brake intervention maintains the desired speed up to a limit of 210 km/h and the set distance to the vehicle in front. When desired, Speed Limit Assist automatically takes over the actual driving speed, which is determined by the speed limit display with no-overtaking indicator and pre-warning. The Steering and Lane Control Assistant with narrow lane support is also available up to 210 km/h. This supports you with active steering interventions in safely steering the vehicle within its lane. The Lane Keeping Assistant with active side collision protection helps prevent collisions. When required, the front collision warning with brake intervention reacts with warnings of increasing intensity and initial braking. In the event of a medical emergency, the Emergency Stop Assistant can, after activation, drive your vehicle for a brief period and bring it to a standstill. Assisted View allows the operating principle of the individual driver assistance systems of the Driving Assistant Professional to be displayed as 3D environment visualisation in real time in the instrument cluster.

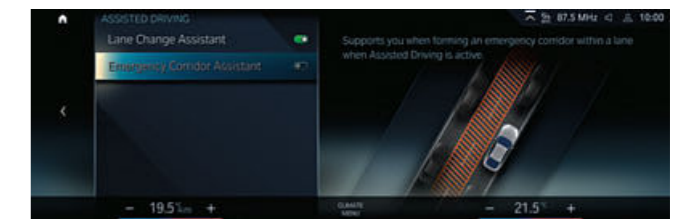

□ The Steering and Lane Control Assistant with extended functions can be activated to support you in monotonous traffic situations. It helps you to keep the vehicle in the centre of its lane, assists you in narrow places and, with active route guidance, makes navigation on motorways easier.

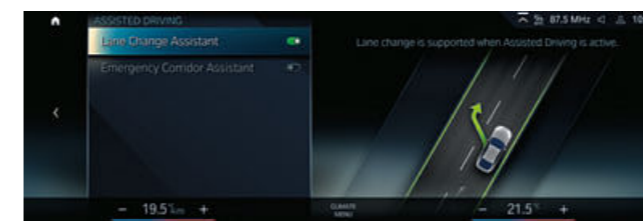

□ The Lane Change Assistant offers you comfortable steering assistance when changing lanes on motorways or other roads with structurally separated lanes. The system functions at speeds of between 70 and 180 km/h. When the Steering and Lane Control Assistant is activated, you can activate it by long-pressing the indicator lever.

□ Within a range of 30 to 160 km/h, Distance Control maintains a pre-defined distance from the vehicle ahead, including stopping and starting again in stop-and-go traffic. Speed Limit Assist allows the takeover of speed limits in the cruise control. The front collision warning with brake intervention reacts to stationary vehicles, pedestrians and cyclists.

□ The Distance Control (ACC with Stop&Go) with traffic light detection stops your vehicle before red lights automatically or after your approval. If you wish, your vehicle can also give you a visual and acoustic reminder when the light switches to green.

□ The Assisted View provides real-time information on the vehicle surroundings collected by various assistance systems. Thanks to an animated 3D display in the instrument cluster, you can clearly see how your vehicle perceives the current traffic situation and thus understand how the systems work.

■ Standard equipment □ Optional equipment

¹ Standard for i4 M50.

² Function may be limited in darkness, fog or bright glare.

The availability of some equipment features, functions and digital services depends on engine versions or additional optional equipment. The offer structure as well as market and production availability may vary. For detailed information about availabilities, duration and costs, contact your local BMW authorised workshop.

EQUIPMENT HIGHLIGHTS.

□ The Parking Assistant Plus¹ makes parking and manoeuvring the vehicle easier. The equipment includes the Surround View system, Active Park Distance Control as well as the Parking and Reversing Assistant. The Surround View system makes parking easier by making the area around the vehicle visible with Top View, a Panorama View with automatic activation as well as a 3D View on the Control Display. Even from a distance, you can see the parked vehicle's surroundings with Remote 3D View on your smartphone. When parking manually, additional sensors monitor the areas on the sides of the vehicle and obstacles are represented on the Control Display. The Active Park Distance Control emergency braking function helps prevent collisions during reverse parking. Park Assistant parks your BMW automatically in parking spaces that are parallel or perpendicular to the street, and can also leave parallel parking spaces automatically. The system measures potential parking spaces while driving slowly past them (at speeds below 35 km/h) and at a maximum distance of 1.5 m from the row of parked vehicles. Once a sufficiently sized parking space has been found, you just need to turn on the indicator and the Parking Assistant takes over the steering, and covers gear selection and acceleration. All you need to do is monitor the parking process. If you have driven a route forwards while manoeuvring, Reversing Assistant records up to 50 m of this route so that the vehicle can be driven backwards on the same route if you wish.



■ The Reversing Assist Camera ensures better orientation when reversing below 20 km/h, for example when parking. It shows the area behind the BMW on the Control Display. Interactive tracer lines for measuring distance and turning circles and a zoom function when towing a trailer assist when manoeuvring. Obstacles to avoid are marked in colour.

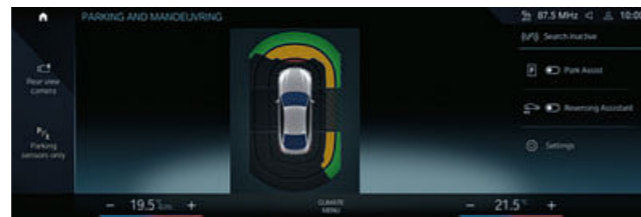

□ The Lateral parking aid is a part of Park Distance Control and gives you an "all-round view" near the vehicle during manoeuvring. In this way, obstacles on the sides of the vehicle are detected and signalled audibly and visually.

■ Standard equipment □ Optional equipment

¹ The driver is responsible for constantly monitoring the automated parking procedure in accordance with local road laws.

The availability of some equipment features, functions and digital services depends on engine versions or additional optional equipment. The offer structure as well as market and production availability may vary. For detailed information about availabilities, duration and costs, contact your local BMW authorised workshop.

EQUIPMENT HIGHLIGHTS.



□ In laser high-beam mode, the Adaptive BMW Laserlight illuminates a range of up to 550 m, nearly twice as far as that of conventional headlights. Better visibility in the dark significantly increases safety. Blue accents and the lettering "BMW Laser" in the headlight also underline the technological standards and the sporting character of the vehicle.



□ The M lights Shadow Line include a black finish of all chrome elements in the headlights, creating an unmistakable design.



□ Ambient light, including Ambient contour lighting in the doors, creates a relaxed, cosy lighting atmosphere in the interior. The dimmable lighting designs also include a dynamic function in four applications. The Welcome Light Carpet illuminates the area in front of the vehicle doors when entering and exiting.

■ Standard equipment □ Optional equipment

The availability of some equipment features, functions and digital services depends on engine versions or additional optional equipment. The offer structure as well as market and production availability may vary. For detailed information about availabilities, duration and costs, contact your local BMW authorised workshop.

EQUIPMENT HIGHLIGHTS.

□ The glass sunroof with slide and lift function, including an electric sliding interior roof, anti-trap protection, as well as comfort opening and closing, allows the airflow to be individually regulated to create a pleasant interior climate. The integrated wind deflector prevents draughts from developing in the interior and ensures a lower level of wind noise.



□ The Automatic air conditioning with 3-zone control and automatic temperature control features separate controls for you and your front passenger, as well as for the passengers in the rear. It also includes Automatic Air Recirculation (AAR), a micro active carbon filter, a fog and solar sensor, as well as rear air vents with a digital display.



□ The seat heating increases the temperature of the seat and backrest surfaces of the front seats as well as the exterior rear seats. It can be individually regulated to three levels for each seat.

□ The storage compartment package includes a fold-down compartment on the driver's side of the instrument panel, nets on the back of the front-seat backrests, as well as two USB ports with charging function in the rear centre console. There is also a storage net on the left and right side for smaller items and a multipurpose hook in the luggage compartment. Additional 12 V power sockets are located in the rear centre console and in the luggage compartment.



□ The electric seat adjustment makes it particularly convenient and easy to adjust the driver and front passenger seats. The memory function enables drivers to save and retrieve their desired settings for the driver's seat and exterior mirrors at the push of a button.



■ Standard equipment □ Optional equipment

The availability of some equipment features, functions and digital services depends on engine versions or additional optional equipment. The offer structure as well as market and production availability may vary. For detailed information about availabilities, duration and costs, contact your local BMW authorised workshop.

EQUIPMENT HIGHLIGHTS



□ The Comfort Access makes it possible to open all of the vehicle doors and the luggage compartment, without using the key. When approaching, the welcome greeting is activated even before the doors unlock automatically. You can additionally set up a BMW Digital Key on an iPhone – if compatible – or use the Key Card for accessing and starting the vehicle.



□ No need to take the key with you as long as you have your iPhone with you. You can lock and unlock your BMW and even start it with the BMW Digital Key¹. You can also authorise up to five people with compatible iPhones to use your BMW. Among other things, the maximum speed can be limited – ideal for novice drivers.

□ The fast charging cable (mode 3) for public charging allows you to conveniently charge the vehicle battery at public charging stations. It can be used for 1-phase charging at up to 7.4 kW charging capacity and for 3-phase charging at up to 11 kW³. The five-metre charging cable is supplemented with a useful storage bag.



□ With BMW IconicSounds Electric², you can further enhance the emotional experience of purely electric driving. The sound productions give you immediate acoustic feedback on various driving manoeuvres. Internally, the sound is output via the audio system.



■ Standard equipment □ Optional equipment

¹ Prerequisite is a BMW ConnectedDrive account and a compatible smartphone. For customers with a non-compatible smartphone, a high-quality Key Card is provided. More information about the BMW Digital Key, e.g. regarding the compatibility of your smartphone, is available at www.bmw.com/digitalkey

² Standard for i4 M50.

³ Up to 11 kW in the BMW i4.

The availability of some equipment features, functions and digital services depends on engine versions or additional optional equipment. The offer structure as well as market and production availability may vary. For detailed information about availabilities, duration and costs, contact your local BMW authorised workshop.

EXTERIOR COLOUR WORLD.

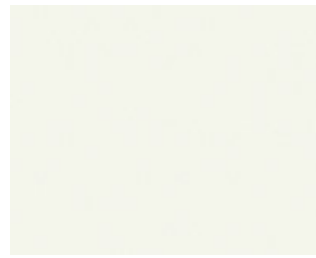

□ Non-metallic 300 Alpine White¹



■ Non-metallic 668 Black²

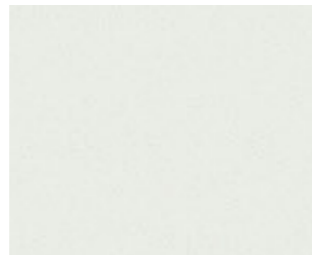

□ Metallic A96 Mineral White



□ Metallic C4P M Brooklyn Grey³

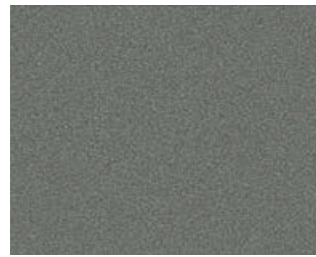

□ Metallic C4W Skyscraper Grey²



□ Metallic 475 Black Sapphire

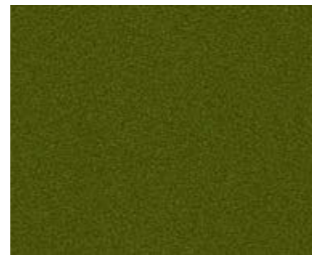

□ Metallic C4E Sanremo Green



□ Metallic C31 M Portimao Blue³

BMW INDIVIDUAL

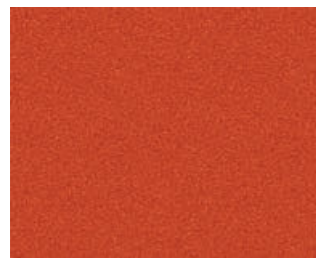

□ Metallic C1X Sunset Orange

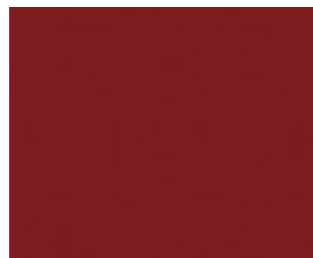

□ Metallic C57 Aventurine Red

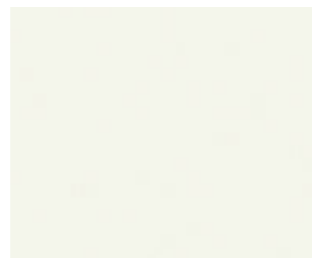

□ BMW Individual 490 special paintwork (up to 150 points available)



□ BMW Individual special paintwork Frozen Pure Grey metallic³

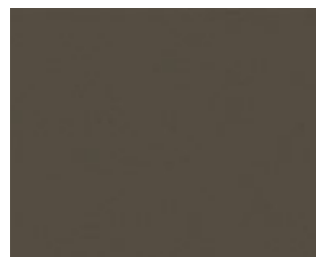

□ BMW Individual C36 Dravite Grey metallic

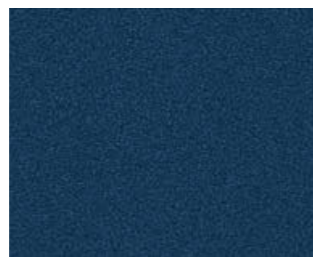

□ BMW Individual C3Z Tanzanite Blue metallic

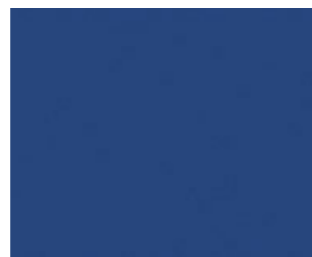

□ BMW Individual special paintwork Frozen Portimao Blue metallic³



□ BMW Individual 490 special paintwork (up to 150 points available)



Make an individual statement. BMW Individual special paintwork offers you countless possibilities to highlight the exclusivity of your BMW i4. Simply scan the QR code or ask your Authorised BMW Retailer.

■ Standard equipment □ Optional equipment

[Colour samples] These colour samples are intended as an initial guide to the colours and materials available for your BMW. However, experience has shown that printed versions of paint, upholstery and interior trim colours cannot in all cases faithfully reproduce the appearance of the original colour. Please discuss your preferred colour choices with your BMW partner or in your dealership. There you can also see original samples and be assisted with special requests.

¹ Available as standard for the M Sport package and i4 M50.

² Not available for the M Sport package and i4 M50.

³ Only available for M Sport package and i4 M50.

The availability of some equipment features, functions and digital services depends on engine versions or additional optional equipment. The offer structure as well as market and production availability may vary. For detailed information about availabilities, duration and costs, contact your local BMW authorised workshop.

INTERIOR COLOURS.

UPHOLSTERY COLOURS



■ Cloth/Sensatec combination KFSW Black¹



□ Alcantara/Sensatec combination KGNL Black with perforation, accent Blue^{2,3}



□ Sensatec perforated KHFR Canberra Beige



□ Sensatec perforated KHFS Canberra Beige



□ Sensatec perforated KHG7 Tacora Red



□ Sensatec perforated KHKC Cognac



□ Sensatec KHSW perforated Black



□ Leather 'Vernasca' MAG6 Tacora Red with decorative stitching



□ Leather 'Vernasca' MAH7 Black decor stitching

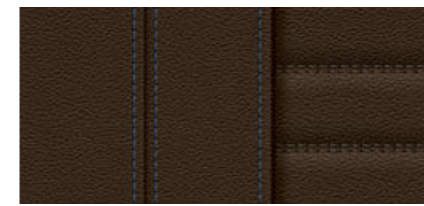

□ Leather 'Vernasca' MAMU Mocha decor stitching

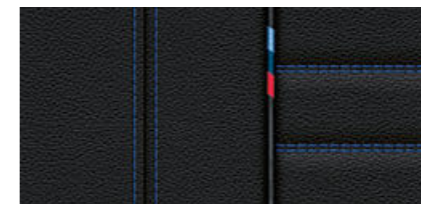

□ Leather 'Vernasca' MANL Black, Blue contrast stitching²



□ Leather 'Vernasca' MAOI Oyster decor stitching



□ Leather 'Vernasca' MAPQ Cognac decor stitching²

■ Standard equipment □ Optional equipment

¹ Not available for i4 M50.

² Only available for M Sport package and i4 M50.

³ Available as standard for the M Sport package and i4 M50.

The availability of some equipment features, functions and digital services depends on engine versions or additional optional equipment. The offer structure as well as

market and production availability may vary. For detailed information about availabilities, duration and costs, contact your local BMW authorised workshop. Please note that even normal long- or short-term use can lead to unrecoverable upholstery damage. This can be caused in particular by non-colourfast clothing. Please note that the interior colour depends on the selected upholstery colour.

INTERIOR COLOURS.

BMW INDIVIDUAL UPHOLSTERY COLOURS



□ BMW Individual extended leather trim 'Merino' VAEW Ivory White



□ BMW Individual extended leather trim 'Merino' VAHZ Fiona Red/Black



□ BMW Individual extended leather trim 'Merino' VATQ Tartufo



□ BMW Individual extended leather trim 'Merino' ZAFV Fjord Blue/Black



□ BMW Individual extended leather trim 'Merino' ZASW Black



□ BMW Individual full leather trim 'Merino' VBEW Ivory White



□ BMW Individual full leather trim 'Merino' VBHZ Fiona Red/Black



□ BMW Individual full leather trim 'Merino' VBTQ Tartufo



□ BMW Individual full leather trim 'Merino' ZBFV Fjord Blue/Black



□ BMW Individual full leather trim 'Merino' ZBSW Black

■ Standard equipment □ Optional equipment

The availability of some equipment features, functions and digital services depends on engine versions or additional optional equipment. The offer structure as well as market and production availability may vary. For detailed information about availabilities, duration and costs, contact your local BMW authorised workshop.

Please note that even normal long- or short-term use can lead to unrecoverable upholstery damage. This can be caused in particular by non-colourfast clothing. Please note that the interior colour depends on the selected upholstery colour.

WHEELS AND TYRES.

■ 17" light alloy wheels V-spoke style 851 Silver Grey uni, wheel size 7.5J x 17 with 225/55 R17 tyres.¹



□ 17" aerodynamic wheels 852 Bicolour Black Grey, gloss-lathed, wheel size 7.5J x 17 with 225/55 R17 tyres.¹



□ 18" light alloy wheels Double-spoke style 853 Bicolour Dark Grey with mixed tyres, gloss-lathed, wheel size front 8.5J x 18 with 245/45 R18 tyres, wheel size rear 9J x 18 with 255/45 R18 tyres.¹



□ 18" aerodynamic wheels 854 in Multicolour Dark Grey uni with mixed tyres, gloss-lathed, wheel size front 8.5J x 18 with 245/45 R18 tyres, wheel size rear 9J x 18 with 255/45 R18 tyres.¹

□ 19" M light alloy wheels Double-spoke style 861 M Bicolour Jet Black uni with mixed tyres, gloss-lathed, wheel size front 8.5J x 19 with 245/40 R19 tyres, wheel size rear 9J x 19 with 255/40 R19 tyres.⁴



□ 20" BMW Individual aerodynamic wheels 862 I Bicolour Black Grey with mixed tyres, gloss-lathed, wheel size front 8.5J x 20 with 245/35 R20 tyres, wheel size rear 9J x 20 with 255/35 R20 tyres.



□ 18" M aerodynamic wheels 858 M Bicolour Black Grey with mixed tyres, gloss-lathed, wheel size front 8.5J x 18 with 245/45 R18 tyres, wheel size rear 9J x 18 with 255/45 R18 tyres.^{2,3}



□ 19" aerodynamic wheels 855 Bicolour Dark Grey with mixed tyres, gloss-lathed, wheel size front 8.5J x 19 with 245/40 R19 tyres, wheel size rear 9J x 19 with 255/40 R19 tyres.¹



□ 19" M light alloy wheels Y-spoke style 859 M Bicolour Jet Black uni with mixed tyres, gloss-lathed, wheel size front 8.5J x 19 with 245/40 R19 tyres, wheel size rear 9J x 19 with 255/40 R19 tyres.²



□ 19" M aerodynamic wheels 860 M Bicolour Black Grey with mixed tyres, gloss-lathed, wheel size front 8.5J x 19 with 245/40 R19 tyres, wheel size rear 9J x 19 with 255/40 R19 tyres.²



□ 20" M light alloy wheels Double-spoke style 868 M Bicolour Jet Black uni with mixed tyres and sport tyres, gloss-milled, wheel size front 8.5J x 20 with 255/35 R20 tyres, wheel size rear 10J x 20 with 285/30 R20 tyres.⁴

■ Standard equipment □ Optional equipment

¹ Not available for i4 M50.

² Only available for M Sport package and i4 M50.

³ Standard for i4 M50.

⁴ Only available for i4 M50.

The availability of some equipment features, functions and digital services depends on engine versions or additional optional equipment. The offer structure as well as market and production availability may vary. For detailed information about availabilities, duration and costs, contact your local BMW authorised workshop.



BMW INDIVIDUAL.

Make your own ideas reality with the luxurious, high-quality equipment of BMW Individual, and create the car of your dreams. Exclusive BMW Individual Dravite Grey metallic paintwork emphasises the sheer style of your BMW i4, while selected design features in the interior accentuate the vibrancy of the vehicle to suit your taste.

Goosebumps the second you enter the vehicle: glance at the high-quality full leather 'Merino' trim in Fiona Red/Black with interior trim in Piano Finish Black, then take in the exclusive luxurious atmosphere throughout the interior. Take your seat, enjoy the stylish feel of the immaculate soft leather, and experience a moment of pure elegance you'll never forget.

20" BMW Individual aerodynamic wheels 8621 Bicolour Black Grey with mixed tyres, gloss-lathed, wheel size front 8.5J x 20 with 245/35 R20 tyres, wheel size rear 9J x 20 with 255/35 R20 tyres.



A whole-tone appearance: the interior trim in Piano Finish Black are inspired by a piano keyboard, and reflect the extraordinary craftsmanship that goes into the vehicle. Several layers of Piano Finish Black are applied, and polished multiple times to create a high-gloss effect – an exceptional visual highlight.

If someone decides, then you: BMW Individual offers you all the options to customise the BMW i4 according to your wishes, with the degree of customisation entirely up to you. Add your personal driving experience to the typical BMW driving pleasure. Choose what suits you the most from particularly high-quality equipment options: Exclusive BMW Individual paintwork with which you can demonstrate your personal style to the world. Soft, expansive leather trims and interior trim finishers made of fine woods, which turn the interior into your personal comfort zone. Or go your very own way, only following your ideas – BMW Individual ensures that they will become an automotive reality.

The availability of some equipment features, functions and digital services depends on engine versions or additional optional equipment. The offer structure as well as market and production availability may vary. For detailed information about availabilities, duration and costs, contact your local BMW authorised workshop.



ORIGINAL BMW ACCESSORIES.

Intensive driving experiences, even further enhanced: Original BMW accessories are the best match for an original BMW. Whether you're looking for wheels and tyres, transport and luggage compartment solutions, interior equipment,

communication, information and technology, charging accessories or M performance parts, with genuine BMW accessories you'll find exactly the individual solution that will allow you to discover driving pleasure as if for the first time.



WHEELS AND TYRES.

With original BMW complete wheels, you'll reach your destination safely, and emphasise the sporty appearance of your BMW from the very first glance. But what you don't immediately realise is that they are precisely tailored to your BMW, are subject to very stringent tests with intensive material and function checks, and have been developed in close collaboration with leading tyre manufacturers – individually tuned to the driving dynamics and design language of each individual BMW model.

TRANSPORT AND LUGGAGE COMPARTMENT SOLUTIONS.

Original BMW Accessories offer you a wide range of transport and luggage compartment solutions. In line with your personal preferences and interests, you can use them to create additional space whenever and wherever you need it. Whether carrier systems or accessories for the luggage compartment, you can always rely on original BMW accessories to be precisely tailored to your BMW, and easy to use.



INTERIOR ACCESSORIES.

A perfect fit: all original BMW accessory products for the interior help to design the interior of your BMW to fully meet your personal preferences. In addition to the excellent functionality of original BMW accessories, you are also always choosing attractive BMW design alongside extraordinary craftsmanship and material quality – combined with an ambience that will excite you every time you drive.



COMMUNICATION, INFORMATION AND TECHNOLOGY.

Cutting-edge functions and features for maximum freedom and flexibility: Original BMW accessories for communication, information and technology are always at your side. Whether you value optimum availability by phone or the best sound, the innovative original BMW accessories will have the right solution for you. You'll always enjoy a good connection and custom entertainment, wherever your journey takes you.

CHARGING ACCESSORIES.

Regardless of where and how you want to charge your new BMW, original BMW charging accessories offer you tailor-made products and services. You can charge your BMW at any domestic socket using the BMW Flexible Fast Charger or, for even more convenience, at a BMW Wallbox from original BMW accessories; what's more, there's also a widespread network of public charging points available for when you're on the road. Innovative Connected Charging services show charging stations in your BMW's information display, for example, or enable you to easily start pre-conditioning your vehicle just using your smartphone.



M PERFORMANCE PARTS.

With M performance parts, you can experience BMW's motorsport DNA with fascinating intensity, even off the racetrack. A wide range of technical and visual components makes outstanding technology a visible and tangible experience. Exclusive materials and first-rate quality guarantee flawless dynamism. Experience inspiring maximum product performance: individual, expressive and uncompromising.



The availability of the equipment shown and described may vary on a market-specific basis. Your local BMW partner will be happy to advise you on the full range of original BMW accessories.

Discover the whole range of original BMW accessories and the BMW M performance parts product portfolio.



ORIGINAL BMW ACCESSORIES.



o 18" BMW light alloy wheel Double-spoke style 853 in Gunmetal Grey. Winter complete wheel with tyre pressure monitor, compatible with snow chains, wheel size 8.5J x 18.



o 17" BMW aerodynamic wheel V-spoke style 852 in Bicolor Midnight Grey, gloss-lathed. Winter complete wheel with tyre pressure monitor, compatible with snow chains.

o The BMW roof cycle carrier is the safe transport solution for racing, touring or children's bikes as well as for mountain bikes up to a maximum of 20 kg. Its operating elements are conveniently located at roof rack height. If necessary, the loading side can be converted from right to left.



o BMW WaterBlade is a windscreen wiper for the windscreen with innovative wiper technology – for significantly more effective cleaning performance.

o In the event of disturbances, the highly sensitive full-HD camera automatically records the situation in front of and behind the car.



o The modern BMW roof box in black with titanium silver side panels has a storage capacity of 420 litres and is compatible with all BMW roof rack systems. Due to the fact that it can be opened from both sides and has triple central locking on each side it is convenient to load and lock for theft protection.



o Precisely fitted protection against moisture and dirt in the front footwell. Featuring a black design with a stainless steel inlay, they perfectly complement the interior.

o The safety case offers optimal protection for all 10.5" Apple iPad™ Pro.



o The clothes hanger can be snapped into the basic carrier or the optional equipment "Travel & Comfort" and can also be used outside of the car.

o Firm hold for tablets with BMW safety case. The adjustable holder is attached to the basic carrier or to the optional equipment "Travel & Comfort".



o Like a filling station at home. With the BMW Wallbox, the BMW is charged fast, reliably and conveniently with up to 22 kW.

o Accessories

The availability of the equipment shown and described may vary on a market-specific basis. Your local BMW partner will be happy to advise you on the full range of original BMW accessories.

TECHNICAL VALUES.

BMW i4		i4 eDrive40	i4 M50
Weight and volume			
Unladen weight EU (xDrive) ¹	kg	2125	2290
Max. permissible weight (xDrive)	kg	2605	2735
Luggage capacity	l	470–1290	470–1290
Output and torque			
• System output	kW (hp)	250 (340)	400 (544)
• System torque	Nm	430	795
Lithium-ion high-voltage battery			
Net battery capacity	kWh	80.7	80.7
Charging time (AC 0–100 %) ²	h	8.25	8.25
Charging time (DC 10–80%) ²	min	31	31
Power transmission			
Type of drive	–	Rear-wheel	All-wheel
Performance			
Top speed (xDrive)	km/h	190	225
Acceleration 0–100 km/h (xDrive)	s	5.7	3.9
Consumption and range^{3,5}			
• Power consumption, combined ⁴	kWh/100 km	19.1–16.1	22.5–18.0
• Electric range (xDrive) ⁶	km	up to 590	416–521
Wheels/tyres			
Standard wheels	–	Front: 225/55 R17 101 Y XL Rear: 225/55 R17 101 Y XL	Front: 245/45 R18 100 Y XL Rear: 255/45 R18 103 Y XL

TECHNICAL VALUES.

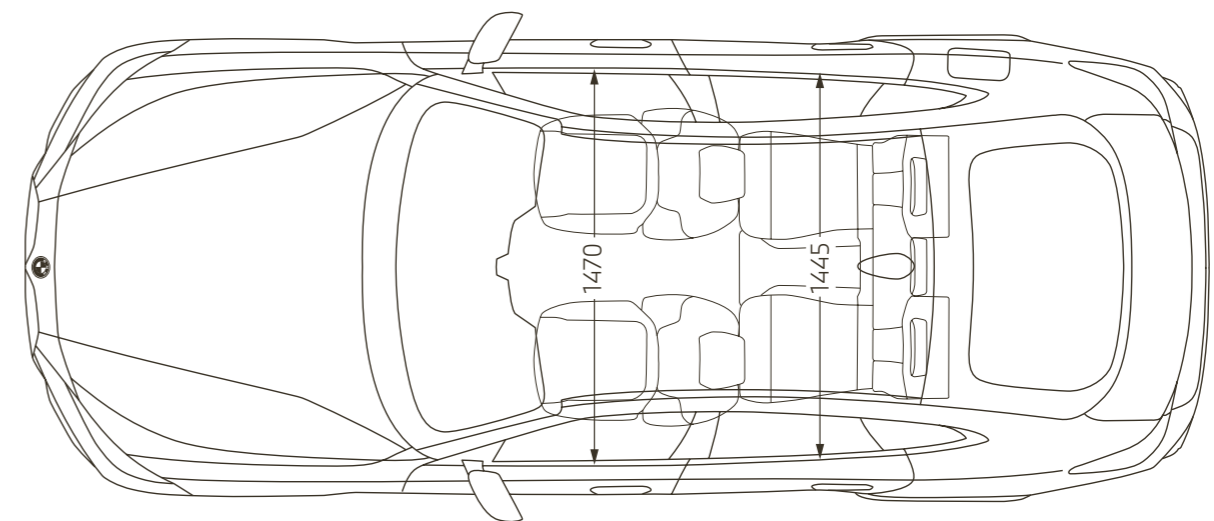
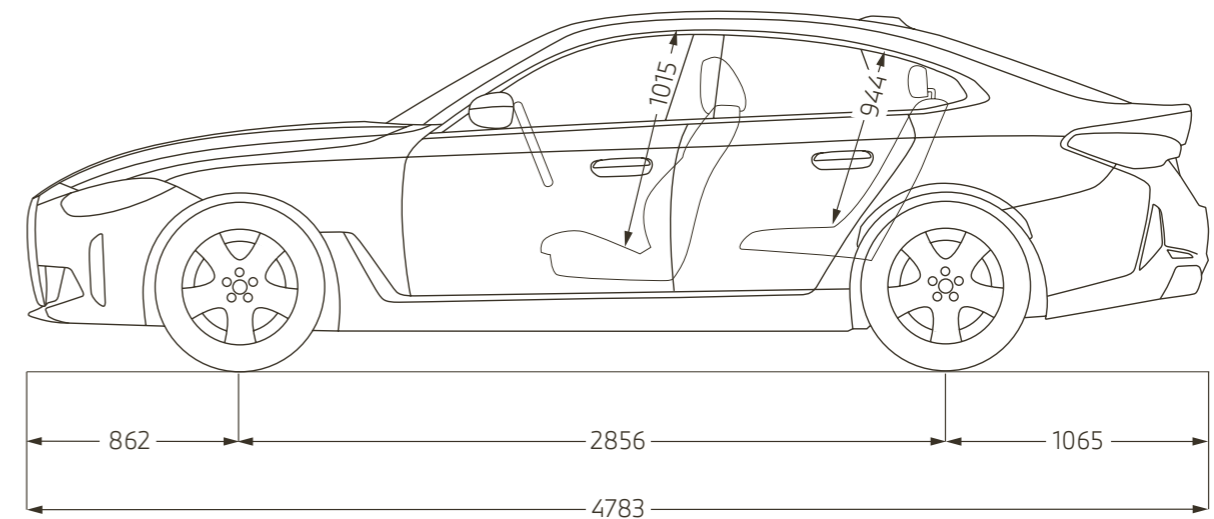
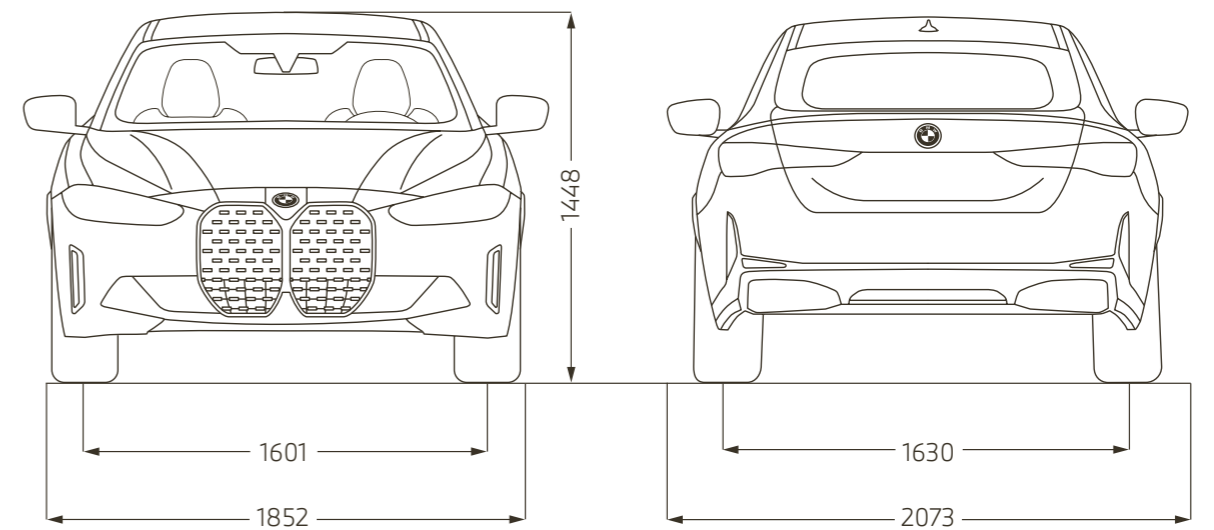

¹ The figures quoted are based on a driver weight of 75 kg. Unladen weight applies to vehicles with standard equipment. Optional equipment may affect the weight of the vehicle, the payload and the top speed if the equipment has an impact on the vehicle's aerodynamics.

² Dependent on the local electricity infrastructure. AC charging time refers to a charging power of 11 kW; DC charging time refers to a charging power of 205 kW.

³ Official data for power consumption and electric range was determined in accordance with the prescribed measuring procedure and corresponds to European Regulation (EU) 715/2007 in the applicable version. For ranges, data determined as per WLTP takes into account any optional equipment (available on the German market in this case). For vehicles that have been newly type approved since 1 January 2021, only the official data according to WLTP exists. For more information about NEDC and WLTP measuring procedures visit www.bmw.com/wltp

⁴ The combined energy consumption depends on the selected wheel and tyre sizes.

⁵ As of 1 September 2017, the type approval for certain new vehicles is granted according to the Worldwide harmonised Light vehicles Test Procedure (WLTP), a new, more realistic test procedure to measure the fuel consumption and carbon dioxide emissions. As of 1 September 2018, the WLTP replaced the New European Driving Cycle (NEDC), the previous test procedure. As a result of the more realistic test conditions, the fuel consumption and CO₂ emission values measured as per WLTP are, in many cases, higher than the values measured according to the NEDC.

⁶ Range depends on various factors, in particular: individual driving style, route characteristics, outside temperature, heating/air conditioning, pre-conditioning.

The dimensions in the technical drawing are in millimetres and may vary depending on the model and optional equipment.



BMW SERVICE.



Always there for you: Your BMW Service Partner is there for helpful, expert support for everything to do with your BMW. Our aim is to make every journey in your BMW as pleasant as possible. A major worldwide network of workshops offers premium service from BMW specialists, innovative diagnostic technologies, and rapid availability of precisely fitting original BMW parts as well as original BMW engine oil. There are many great reasons to choose services from BMW, but there's one that really stands out: that driving pleasure that sets your BMW apart from the crowd will be yours to enjoy for many years to come with BMW Service.

WHEREVER, WHENEVER: OUR COMPREHENSIVE SERVICE.

Many BMW services can be easily booked and tracked online – so you can use your time for the really important things in life. Stay independent and flexible with online appointments and remote services. Take advantage of our innovative digital products and services such as online video advice, and get all the relevant information on your smartphone. And if you don't want to stop but have no choice, our BMW Breakdown and Accident Assistance service will help.



BMW SERVICE INCLUSIVE.

Just let go and concentrate only on what really counts: the joy of driving. You can do precisely that with BMW Service Inclusive because, with just one payment, you're covered for all included service and maintenance work for a duration of your choice, and can drive worry-free and without any hidden costs. Your BMW is always in the best hands – at all participating BMW service partners worldwide.



BMW WARRANTY EXTENSION.

With the BMW dealer warranty, you are protected against unexpected repair costs for 24 months. But you'll have no need to worry even after then due to the option of extending your warranty to up to 5 years.

MY BMW APP.

With the My BMW app, the digital world of BMW is always easily within reach on your smartphone. It offers a wide range of services and functions that make your life easier – before, during and after every journey. For example, the My BMW App notifies you when your BMW needs a service and offers an easy way to arrange a service appointment with your BMW Service Partner; just one more reason to enjoy the pleasure of driving.



The availability of the services shown and described may vary on a market-specific basis. Your local BMW partner will be happy to advise you on the full range of products and services from BMW Service.

NOTE

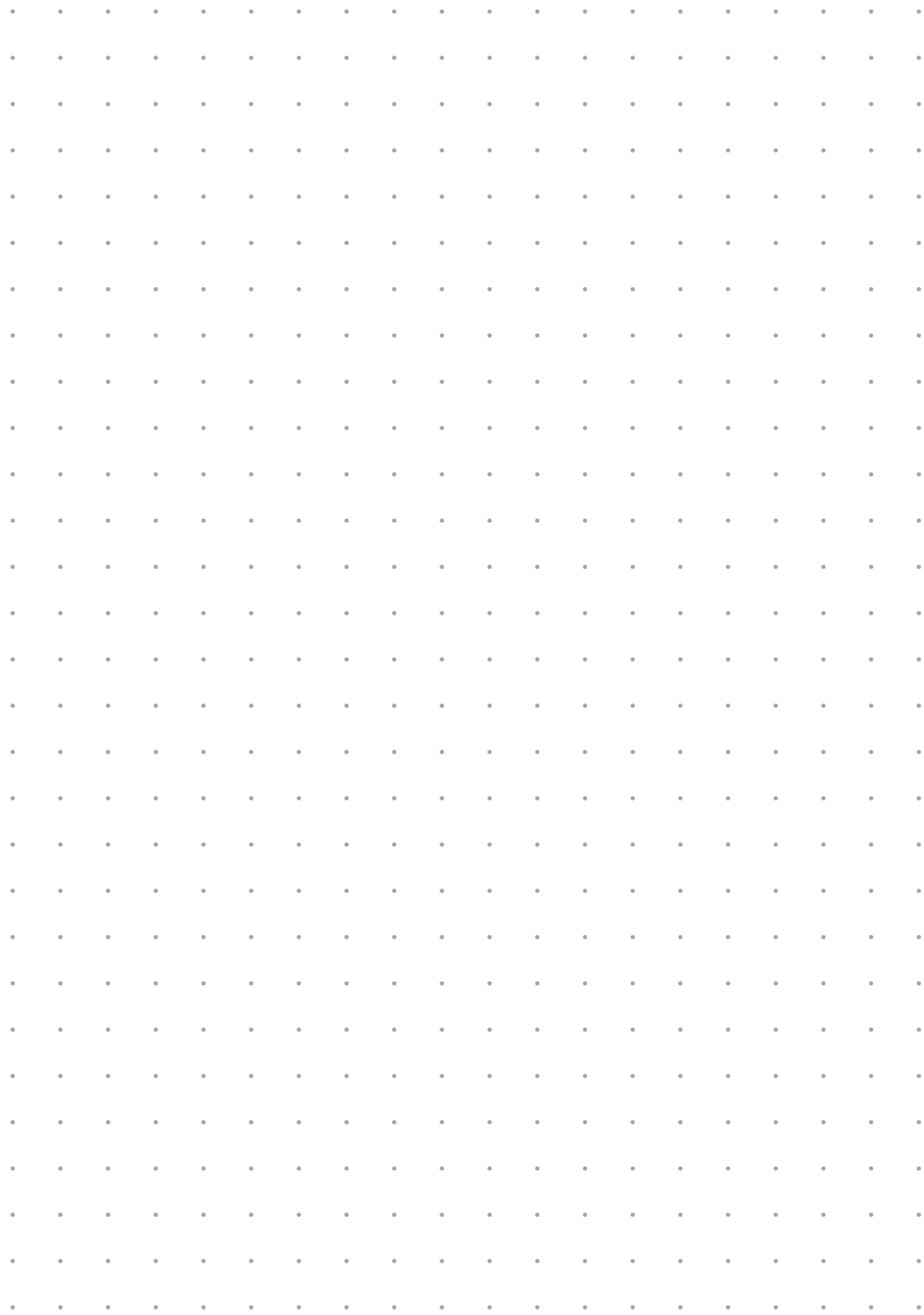

NOTE

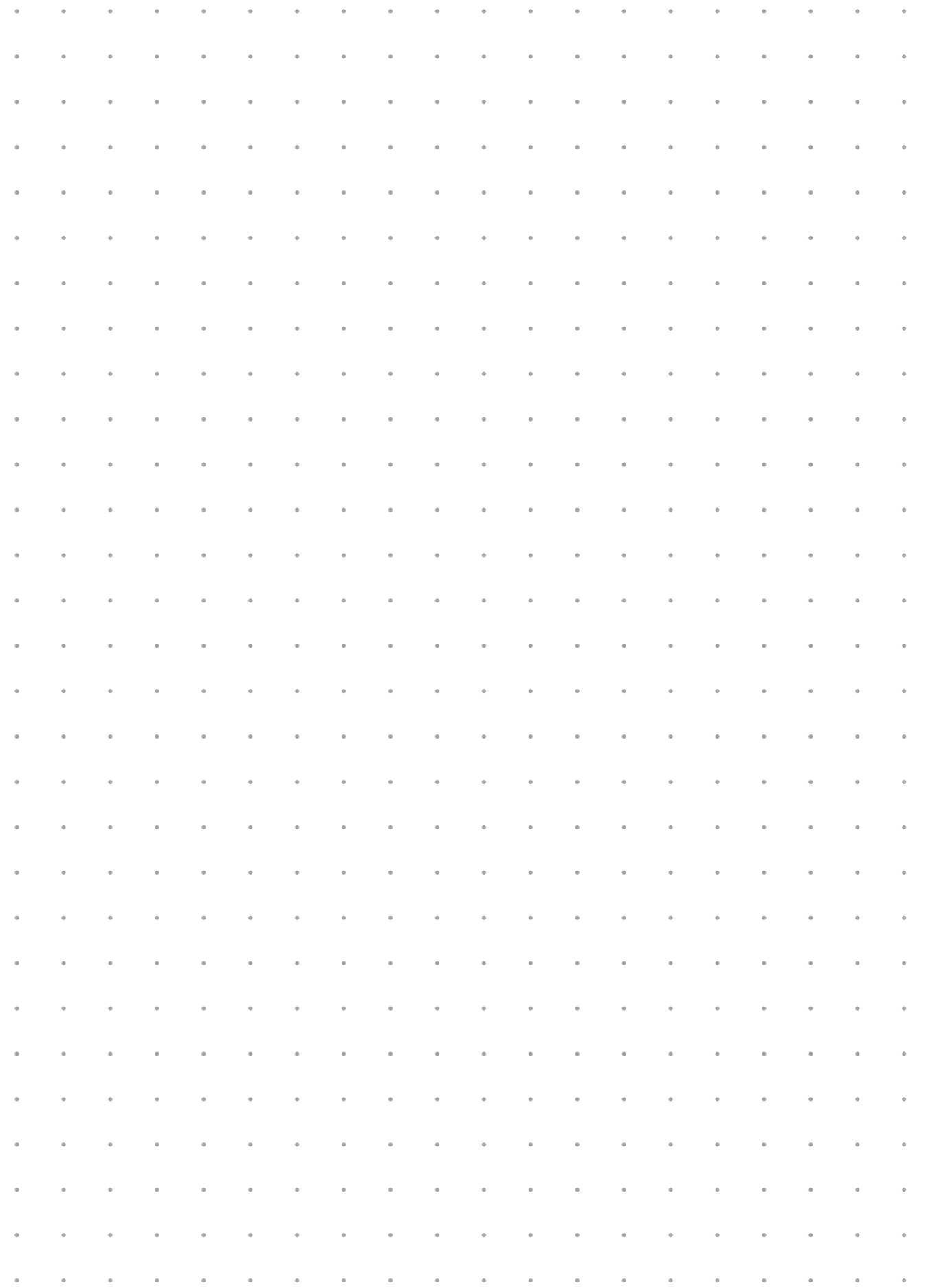

SUSTAINABILITY, TANGIBLY EFFECTIVE.

Sustainability has many facets – and each one of them is important. For this reason, the printed product that you hold in your hands is printed on NAUTILUS® paper made by the manufacturer Mondi.

This uncoated paper consists entirely of recycled waste paper, meets the EU Ecolabel requirements among others and was certified by the Forest Stewardship Council, an international non-profit organisation for the protection of forests. Any pulp that is used originates exclusively from FSC™-certified, sustainably managed forests.

To reduce the ecological footprint even further, investments are being made in the Pesqueiro hydropower plant to compensate the CO₂ generated during production, saving some 20,000 tons of CO₂ emissions every year.

This results in CO₂-neutral paper – a result that you can feel but that, above all, helps to preserve our planet's resources for all future generations.



Of course, each vehicle is designed for economical recycling after its long-running life. You can find more information regarding your end-of-life vehicle on our website **www.bmw.de/recycling**

© BMW AG, Munich, Germany. Not to be reproduced wholly or in part without prior written permission of BMW AG, Munich.

411 009 542 20 3 2022 CB.